

.mdd

Panele i blendy
v7.2022

Zestawienie kolorystyczne - Sonic - panele biurkowe

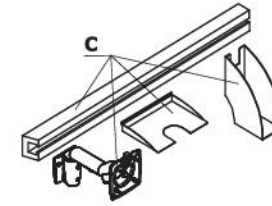
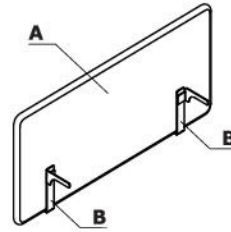
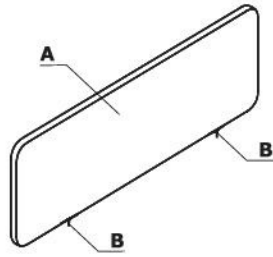

Materiał	Kolor	Panele														
		A - Panel	B - Uchwyt	C - Akcesoria												
Tkanina	Nemo	✓														
	Runner	II grupa ✓														
	Medley	II grupa ✓														
	**Atlantic	II grupa ✓														
	Vita	II grupa ✓														
	Mica	II grupa ✓														
	Go Check	II grupa ✓														
	****Charles	II grupa ✓														
	*Tkanina powierzona	II grupa ✓														
	Synergy	III grupa ✓														
	***Silvertex	III grupa ✓														
	Tessa	III grupa ✓														
	Oceanic	III grupa ✓														
	Quest	III grupa ✓														
	Grain	III grupa ✓														
	Atlas	IV grupa ✓														

* Zastosowanie tkaniny powierzonej wymaga przeprowadzenia prób tapicerskich, w celu sprawdzenia możliwości wykonawczych

** Istnieje możliwość zamówienia produktu w pełnej kolorystyce Atlantic wg wzornika Gabriel w terminie nie krótszym niż 7 tygodni

*** Istnieje możliwość zamówienia produktu w pełnej kolorystyce Silvertex wg wzornika Spradling w terminie nie krótszym niż 15 dni roboczych

**** Istnieje możliwość zamówienia produktu w pełnej kolorystyce Charles wg wzornika Dekoma w standardowym terminie realizacji.

Materiał	Kolor	Panele														
		A - Panel	B - Uchwyt	C - Akcesoria												
Metal	M009 - aluminium półmat RAL 9006		✓	✓												
	M015 - biały półmat RAL 9010		✓													
	M115 - czarny półmat RAL 9005		✓													
	M154 - antracyt półmat RAL 7043		✓													

Nabiurkowe - do biurek pojedynczych i biurek typu bench

- 1 Panel Sonic** - tapicerowany, klasa akustyczności "A", możliwość wpinania szpilek
- 2 Zamek błyskawiczny** - ozdobny, bez możliwości odpinania, kolor: grafit
- 3 Rama** - konstrukcja z litego drewna klejonego
- 4 Wypełnienie** - włóknina akustyczna o wysokim stopniu pochłaniania i rozpraszania dźwięków
- 5 Wspornik stalowy** - osadzony w ramie, z gwintem maszynowym do stabilnego mocowania uchwyłów paneli (dotyczy paneli nabiurkowych)

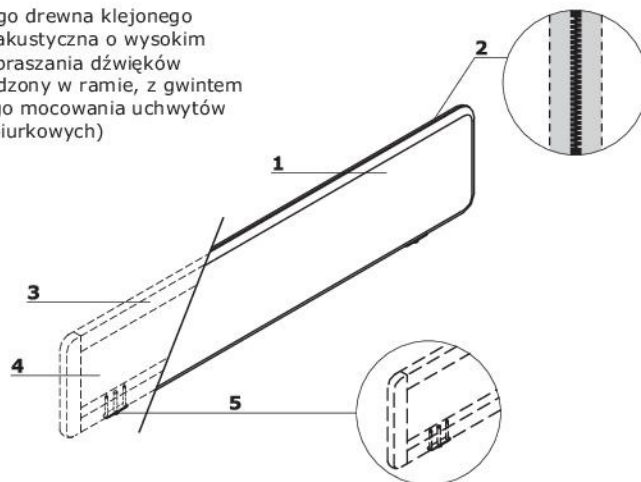

Uchwyt do Ogi Drive - wymiary (mm)

- 1 Uchwyt Ogi Drive** - opcja z dopłatą; mocowany do stelaża; metal malowany proszkowo, profil 60x60 mm

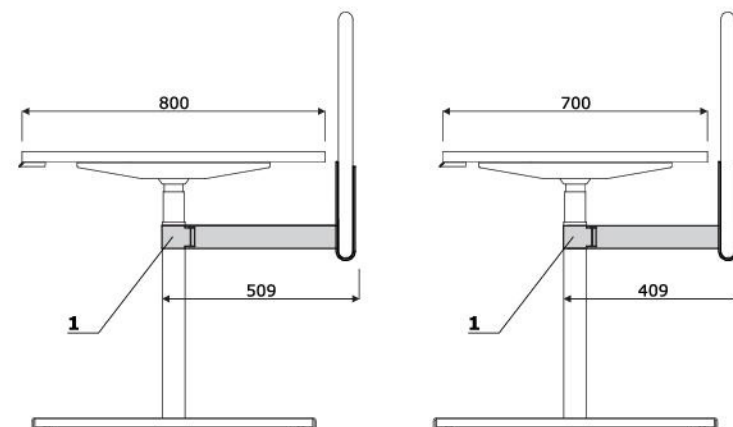

Uwaga - przy zakupie uchwyty Ogi Drive, mocowanego do stelaża - brak możliwości montażu listwy funkcyjnej

Uchwyty do paneli

- 1 Ogi, Ergonomic Master** - uchwyt do biurek pojedynczych (OPCJA Z DOPŁATĄ); przystosowany do montażu do blatów o grubości 16-30 mm
- 2 Ogi** - uchwyt do biurek typu bench w komplecie; metal malowany proszkowo; przystosowany do montażu do blatów o grubości 16-30 mm

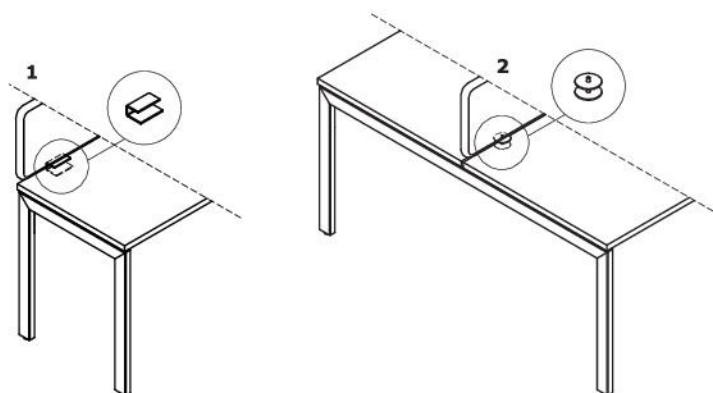

Mocowanie paneli do biurek z blatem przesuwającym

- 1 Uchwyt do biurek pojedynczych** - mocowany do łącznicy metalowej
- 2 Uchwyt do biurek typu bench** - mocowany do łącznicy metalowej

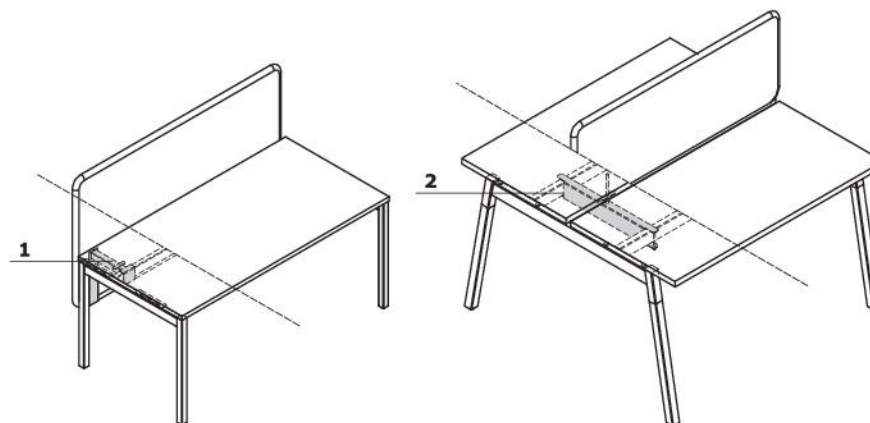

Uwaga - panel należy zamocować przed montażem blatu

Przybiurkowe - do biurek pojedynczych

- 1 Tkanina** - klasa akustyczności "A", możliwość wpinania szpilek
- 2 Mocowanie** - metal malowany proszkowo
- 3 Zamek błyskawiczny** - ozdobny, bez możliwości odpinania, kolor: grafit

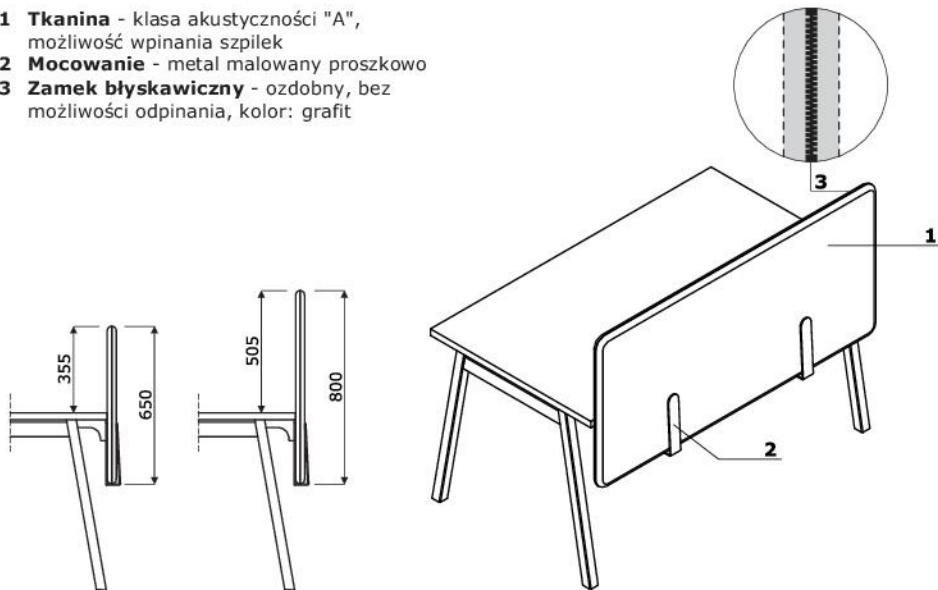
**Boczne - do biurek pojedynczych i biurek typu bench**

- 1 Panele Sonic** - klasa akustyczności "A", możliwość wpinania szpilek, zamek błyskawiczny, brak możliwości odpinania
- 2 Mocowanie paneli bocznych** - metal malowany proszkowo, kolor: M009 - aluminium półmat

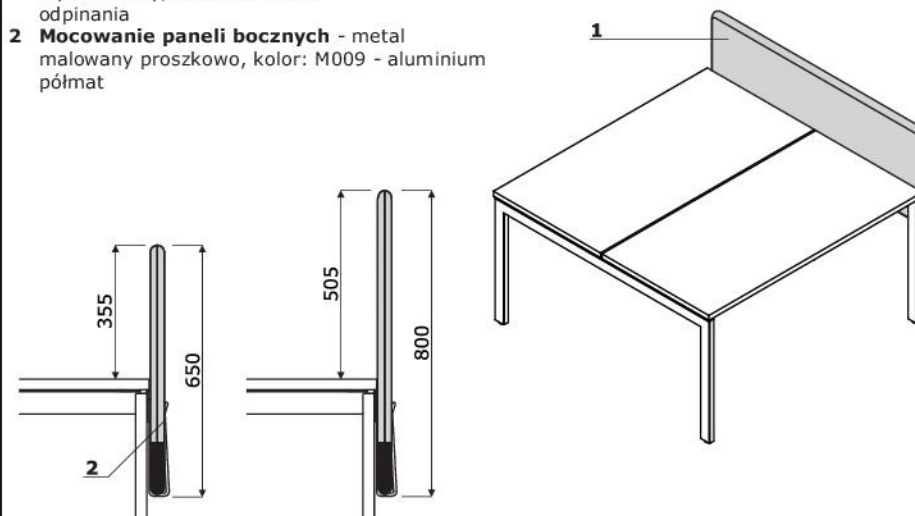
**Poprzeczne - do biurek typu bench**

- 1 Panel Sonic** - klasa akustyczności A, możliwość wpinania szpilek, zamek błyskawiczny ozdobny - kolor: grafit - brak możliwości odpinania
- 2 Mocowanie paneli poprzecznych do biurek Ogi** - stopa 2 szt.

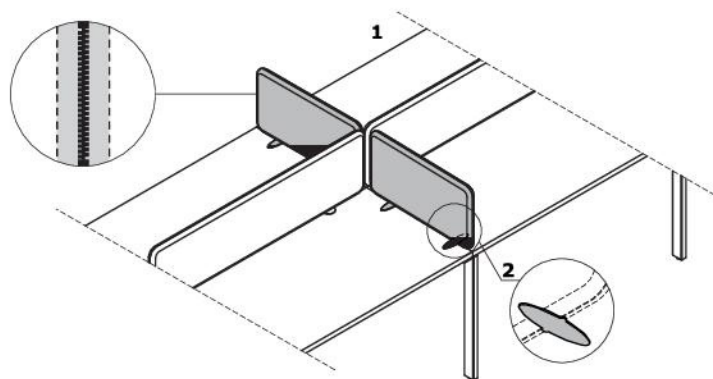
**Dodatki do listwy funkcyjnej**

- 1 Listwa funkcyjna** - max obciążenie: 3,5 kg na punkt, 7 kg na stronę
- 2 Uchwyt na monitor** - metal malowany proszkowo, kolor: M009 - aluminium półmat
- 3 Piórnik** - metal malowany proszkowo
- 4 Półka** - format A4, metal malowany proszkowo
- 5 Organizer** - metal malowany proszkowo

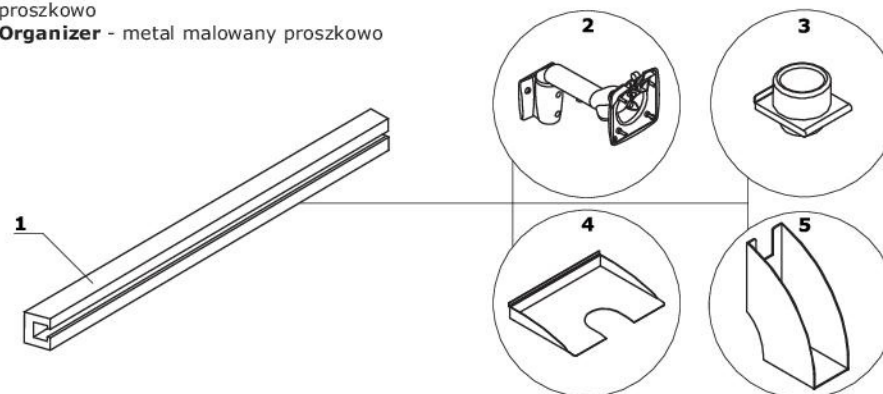

UWAGA: Możliwość mocowania akcesoriów wyłącznie z oferty .mdd

Nabiurkowe - do biurek pojedynczych i biurek typu bench						
Symbol	Wymiary			Waga Obj. Opak.	Uwagi	
	Szer.	Gł.	Wys.			
ZUS01	990	40	350	4.1 kg 0.021 m3 2 szt.	do biurek o szer. 1000mm	
ZUS12	1190	40	350	5.4 kg 0.024 m3 2 szt.	do biurek o szer. 1200mm; Uwaga: możliwość mocowania do pojedynczego biurka, w opcji z dopłatą	
ZUS14	1390	40	350	6.1 kg 0.028 m3 2 szt.	do biurek o szer. 1400 mm; Uwaga: możliwość mocowania do pojedynczego biurka, w opcji z dopłatą	
ZUS16	1590	40	350	6.8 kg 0.032 m3 2 szt.	do biurek o szer. 1600mm; Uwaga: możliwość mocowania do pojedynczego biurka, w opcji z dopłatą	
ZUS18	1790	40	350	7.2 kg 0.035 m3 2 szt.	do biurek o szer. 1800mm; Uwaga: możliwość mocowania do pojedynczego biurka, w opcji z dopłatą	
ZUS20	1990	40	350	8.2 kg 0.039 m3 2 szt.	do biurek o szer. 2000mm; Uwaga: możliwość mocowania do pojedynczego biurka, w opcji z dopłatą	
ZUS05	990	40	500	4.8 kg 0.028 m3 2 szt.	do biurek o szer. 1000mm	
ZUS52	1190	40	500	6 kg 0.033 m3 2 szt.	do biurek o szer. 1200mm; Uwaga: możliwość mocowania do pojedynczego biurka, w opcji z dopłatą	
ZUS54	1390	40	500	7.1 kg 0.039 m3 2 szt.	do biurek o szer. 1400mm; Uwaga: możliwość mocowania do pojedynczego biurka, w opcji z dopłatą	
ZUS56	1590	40	500	7.8 kg 0.047 m3 2 szt.	do biurek o szer. 1600mm; Uwaga: możliwość mocowania do pojedynczego biurka, w opcji z dopłatą	
ZUS58	1790	40	500	8.4 kg 0.049 m3 2 szt.	do biurek o szer. 1800mm; Uwaga: możliwość mocowania do pojedynczego biurka, w opcji z dopłatą	
ZUS59	1990	40	500	8.3 kg 0.054 m3 2 szt.	do biurek o szer. 2000mm; Uwaga: możliwość mocowania do pojedynczego biurka, w opcji z dopłatą	



I grupa cenowa	II grupa cenowa	Schwył do pojedynczego biurka	Zestwa na akcesoria x1	Zestwa na akcesoria x2	III grupa cenowa		

Nabiurkowe - do biurkek typu bench z opcją blatu przesuwne g						
Symbol	Wymiary			Waga Obj. Opak.	Uwagi	
	Szer.	Gł.	Wys.			
ZUS01S	990	40	350	6.1 kg 0.023 m3 2 szt.	do biurkek typu bench o szer. 1000mm	
ZUS12S	1190	40	350	7.4 kg 0.027 m3 2 szt.	do biurkek typu bench o szer. 1200mm	
ZUS14S	1390	40	350	8.1 kg 0.031 m3 2 szt.	do biurkek typu bench o szer. 1400mm	
ZUS16S	1590	40	350	8.8 kg 0.034 m3 2 szt.	do biurkek typu bench o szer. 1600mm	
ZUS18S	1790	40	350	9.2 kg 0.038 m3 2 szt.	do biurkek typu bench o szer. 1000mm	
ZUS20S	1990	40	350	10.2 kg 0.042 m3 2 szt.	do biurkek typu bench o szer. 2000mm	
ZUS05S	990	40	500	6.8 kg 0.031 m3 2 szt.	do biurkek typu bench o szer. 1000mm	
ZUS52S	1190	40	500	8 kg 0.036 m3 2 szt.	do biurkek typu bench o szer. 1200mm	
ZUS54S	1390	40	500	9.1 kg 0.041 m3 2 szt.	do biurkek typu bench o szer. 1400mm	
ZUS56S	1590	40	500	9.8 kg 0.05 m3 2 szt.	do biurkek typu bench o szer. 1600mm	
ZUS58S	1790	40	500	10.4 kg 0.052 m3 2 szt.	do biurkek typu bench o szer. 1800mm	
ZUS59S	1990	40	500	10.3 kg 0.057 m3 2 szt.	do biurkek typu bench o szer. 2000mm	



I grupa cenowa	II grupa cenowa	akcesoria x1	akcesoria x2	III grupa cenowa			

Przybiurkowe - do biurk pojedynczych							
Symbol	Symbol	Wymiary			Waga Obj. Opak.	Uwagi	
		Szer.	Gł.	Wys.			
ZPS610		990	40	650	8.1 kg 0.039 m3 2 szt.	do biurek o szer. 1000mm	
ZPS612		1190	40	650	6.3 kg 0.041 m3 1 szt.	do biurek o szer. 1200mm	
ZPS614		1390	40	650	7.3 kg 0.048 m3 1 szt.	do biurek o szer. 1400mm	
ZPS616		1590	40	650	8 kg 0.054 m3 1 szt.	do biurek o szer. 1600mm	
ZPS618		1790	40	650	7.9 kg 0.061 m3 1 szt.	do biurek o szer. 1800mm	
ZPS620		1990	40	650	10 kg 0.067 m3 1 szt.	do biurek o szer. 2000mm	
ZPS810		990	40	800	9.1 kg 0.047 m3 2 szt.	do biurek o szer. 1000mm	
ZPS812		1190	40	800	7.6 kg 0.05 m3 1 szt.	do biurek o szer. 1200mm	
ZPS814		1390	40	800	8.3 kg 0.058 m3 1 szt.	do biurek o szer. 1400mm	
ZPS816		1590	40	800	9.1 kg 0.066 m3 1 szt.	do biurek o szer. 1600mm	
ZPS818		1790	40	800	9.6 kg 0.075 m3 1 szt.	do biurek o szer. 1800mm	
ZPS820		1990	40	800	10.5 kg 0.082 m3 1 szt.	do biurek o szer. 2000mm	





I grupa cenowa	II grupa cenowa	Ustawia na akcesoria x1	U grupa cenowa	Uchwyt Ogi Drive stelaż			



Przybiurkowe - do biurk pojedynczych z opcją blatu przesuwne

Symbol	Wymiary			Waga Obj. Opak.	Uwagi
	Szer.	Gł.	Wys.		
ZPS610S	990	40	650	7 kg 0.039 m3 2 szt.	do biurk pojedynczych o szer. 1000mm
ZPS612S	1190	40	650	7.1 kg 0.046 m3 2 szt.	do biurk pojedynczych o szer. 1200mm
ZPS614S	1390	40	650	7 kg 0.053 m3 2 szt.	do biurk pojedynczych o szer. 1400mm
ZPS616S	1590	40	650	8 kg 0.059 m3 2 szt.	do biurk pojedynczych o szer. 1600mm
ZPS618S	1790	40	650	9.2 kg 0.066 m3 2 szt.	do biurk pojedynczych o szer. 1800mm
ZPS620S	1990	40	650	11 kg 0.072 m3 2 szt.	do biurk pojedynczych o szer. 2000mm
ZPS810S	990	40	800	8 kg 0.047 m3 2 szt.	do biurk pojedynczych o szer. 1000mm
ZPS812S	1190	40	800	7 kg 0.055 m3 2 szt.	do biurk pojedynczych o szer. 1200mm
ZPS814S	1390	40	800	9 kg 0.063 m3 2 szt.	do biurk pojedynczych o szer. 1400mm
ZPS816S	1590	40	800	9.5 kg 0.072 m3 2 szt.	do biurk pojedynczych o szer. 1600mm
ZPS818S	1790	40	800	10.5 kg 0.08 m3 2 szt.	do biurk pojedynczych o szer. 1800mm
ZPS820S	1990	40	800	11.5 kg 0.088 m3 2 szt.	do biurk pojedynczych o szer. 2000mm

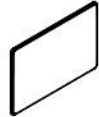
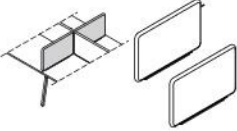

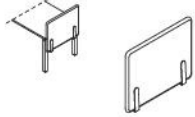
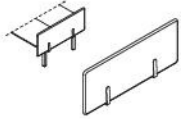

I grupa cenowa	II grupa cenowa	Instwa na akcesoria x1	III grupa cenowa					

Przybiurkowe - do biurek typu bench Ogi Drive							
	Symbol	Wymiary				Waga Obj. Opak.	Uwagi
		Szer.	Gł.	Wys.			
	ZD812	1190	40	800	6.1 kg 0.056 m ³ 2 szt.	do benchy o szer. 1200mm	
	ZD814	1390	40	800	8.6 kg 0.064 m ³ 2 szt.	do benchy o szer. 1400mm	
	ZD816	1590	40	800	7.9 kg 0.066 m ³ 1 szt.	do benchy o szer. 1600mm	
	ZD818	1790	40	800	8.9 kg 0.08 m ³ 2 szt.	do benchy o szer. 1800mm	
	ZD820	1990	40	800	9.3 kg 0.08 m ³ 2 szt.	do benchy o szer. 2000mm	
Poprzeczne - do biurek typu bench Ogi							
	ZYS78	1600	40	350	12 kg 0.03 m ³ 2 szt.	do benchy (kpl. 2 szt.);	
	ZYS79	1600	40	500	6.6 kg 0.042 m ³ 2 szt.		
	ZOS58	577	40	350	3.5 kg 0.011 m ³ 1 szt.	do benchy Ogi (1 szt.);	
	ZOS68	677	40	350	2.7 kg 0.013 m ³ 1 szt.		
	ZOS78	780	40	350	3.2 kg 0.015 m ³ 1 szt.		
	ZOS10	577	40	500	3.1 kg 0.015 m ³ 1 szt.		
	ZOS40	677	40	500	3.4 kg 0.018 m ³ 1 szt.		
	ZOS79	780	40	500	3.7 kg 0.021 m ³ 1 szt.		

I grupa cenowa	II grupa cenowa	III grupa cenowa					

Boczne - do biurek pojedynczych							
Symbol	Wymiary	Wymiary			Waga Obj. Opak.	Uwagi	
		Szer.	Gł.	Wys.			
	ZUS80	600	40	650	4.5 kg 0.021 m3 1 szt.	wysokość panela liczona od poziomu blatu wynosi 350 mm	
	ZUS90	700	40	650	4.6 kg 0.024 m3 1 szt.		
	ZUS30	800	40	650	5.2 kg 0.027 m3 1 szt.		
	ZUS60	600	40	800	7.7 kg 0.025 m3 1 szt.	wysokość panela liczona od poziomu blatu wynosi 500 mm	
	ZUS70	700	40	800	5.4 kg 0.029 m3 1 szt.		
	ZUS50	800	40	800	6.1 kg 0.033 m3 1 szt.		
	Boczne - do biurek typu bench						
	ZUS11	1200	40	650	5.4 kg 0.041 m3 1 szt.	wysokość panela liczona od poziomu blatu wynosi 350 mm	
	ZUS41	1400	40	650	7.1 kg 0.047 m3 1 szt.		
	ZUS31	1600	40	650	7.8 kg 0.053 m3 1 szt.		
	ZUS61	1200	40	800	7.5 kg 0.05 m3 1 szt.	wysokość panela liczona od poziomu blatu wynosi 500 mm	
	ZUS71	1400	40	800	12 kg 0.058 m3 1 szt.		
	ZUS51	1600	40	800	9.1 kg 0.065 m3 1 szt.		

I grupa cenowa	II grupa cenowa	III grupa cenowa							

Akcesoria do listwy funkcyjnej							
	Symbol		Wymiary			Waga Obj. Opak.	Uwagi
			Szer.	Gł.	Wys.		
	D1		300	130	130	1.9 kg 0.012 m3 1 szt.	uchwyt na monitor, max wielkość 22"
	D5		164	83	146	0.2 kg 0.002 m3 1 szt.	Piórnik - tworzywo czarne, uchwyt - metal szary
	D6		327	35	210	0.95 kg 0.002 m3 1 szt.	półka format A4
	D7		93	250	180	0.6 kg 0.004 m3 1 szt.	organizer

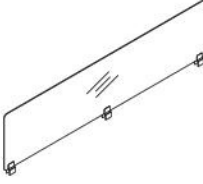
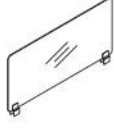
Nadstawka na panel						
	Symbol	Wymiary			Waga Obj. Opak.	Uwagi
		Szer.	Gł.	Wys.		
	PUX12	1190	4	350	4.9 kg 0.006 m3 3 szt.	
	PUX14	1390	4	350	5 kg 0.007 m3 3 szt.	
	PUX16	1590	4	350	7 kg 0.008 m3 3 szt.	
	PUX18	1790	4	350	6.5 kg 0.009 m3 3 szt.	
	PUX20	1990	4	350	7 kg 0.009 m3 3 szt.	
	PUX80	577	4	350	2.15 kg 0.004 m3 3 szt.	
	PUX90	677	4	350	3.2 kg 0.005 m3 3 szt.	
	PUX30	777	4	350	3.1 kg 0.005 m3 3 szt.	

Zestawienie kolorystyczne - Twin - panele biurkowe

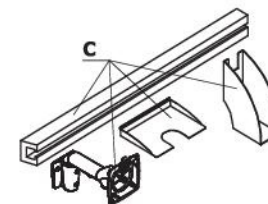
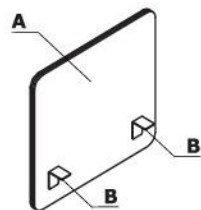
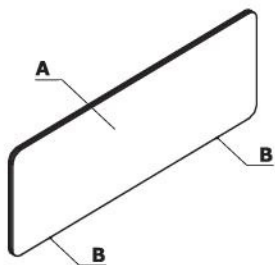

Materiał	Kolor	Panele															
		A - Panel	B - Uchwyt	C - Akcesoria													
Tkanina	Nemo	✓															
	Runner	II grupa ✓															
	Medley	II grupa ✓															
	**Atlantic	II grupa ✓															
	Vita	II grupa ✓															
	Mica	II grupa ✓															
	Go Check	II grupa ✓															
	****Charles	II grupa ✓															
	*Tkanina powierzona	II grupa ✓															
	Synergy	III grupa ✓															
	***Silvertex	III grupa ✓															
	Tessa	III grupa ✓															
	Oceanic	III grupa ✓															
	Quest	III grupa ✓															
	Grain	III grupa ✓															
	Atlas	IV grupa ✓															

* Zastosowanie tkaniny powierzonej wymaga przeprowadzenia prób tapicerskich, w celu sprawdzenia możliwości wykonawczych

** Istnieje możliwość zamówienia produktu w pełnej kolorystyce Atlantic wg wzornika Gabriel w terminie nie krótszym niż 7 tygodni

*** Istnieje możliwość zamówienia produktu w pełnej kolorystyce Silvertex wg wzornika Spradling w terminie nie krótszym niż 15 dni roboczych

**** Istnieje możliwość zamówienia produktu w pełnej kolorystyce Charles wg wzornika Dekoma w standardowym terminie realizacji.

Materiał	Kolor	Panele														
		A - Panel	B - Uchwyt	C - Akcesoria												
Metal	M009 - aluminium półmat RAL 9006		✓	✓												
	M015 - biały półmat RAL 9010		✓													
	M115 - czarny półmat RAL 9005		✓													
	M154 - antracyt półmat RAL 7043		✓													

Nabiurkowe - do biurek pojedynczych i biurek typu bench

- 1 Panel Twin** - tapicerowany, możliwość wpinania pinezek, pasek tworzywowy
- 2 Element dekoracyjny** - pasek tworzywowy, kolor: szary
- 3 Konstrukcja** - płyta wiórowa pokryta obustronnie pianką poliuretanową

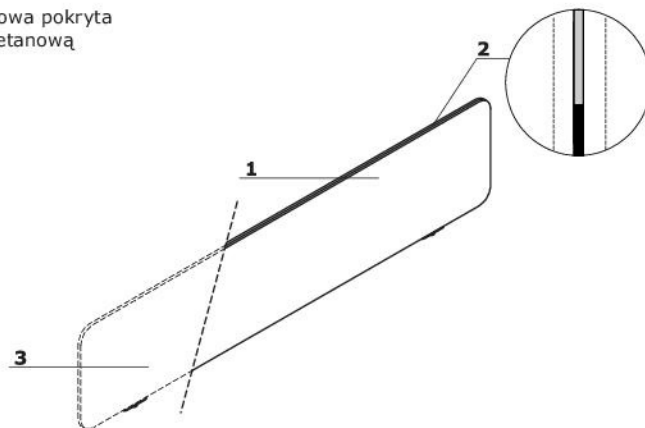

Mocowanie paneli do biurek z blatem przesuwnym

- 1 Uchwyt do biurek pojedynczych** - mocowany do łączyny metalowej
- 2 Uchwyt do biurek typu bench** - mocowany do łączyny metalowej

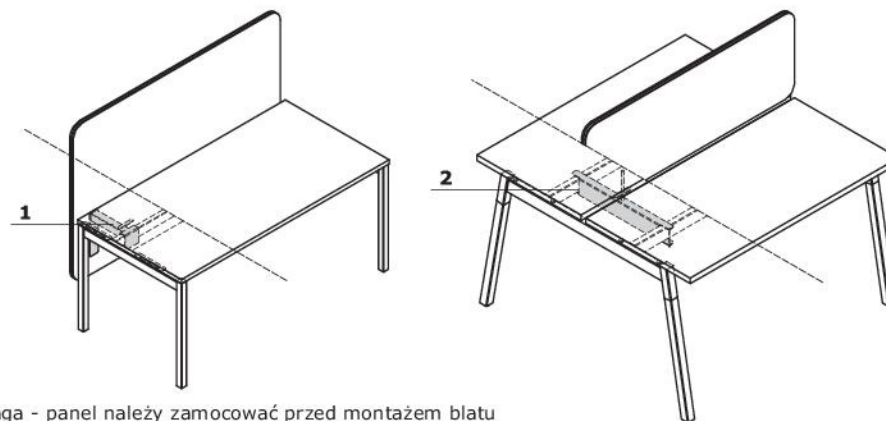

Uchwyty do paneli

- 1 Ogi, Ergonomic Master** - uchwyt do biurek pojedynczych (OPCJA Z DOPŁATĄ); przystosowany do montażu do blatów o grubości 16-30 mm
- 2 Ogi** - uchwyt do biurek typu bench w komplecie; metal malowany proszkowo; przystosowany do montażu do blatów o grubości 16-30 mm

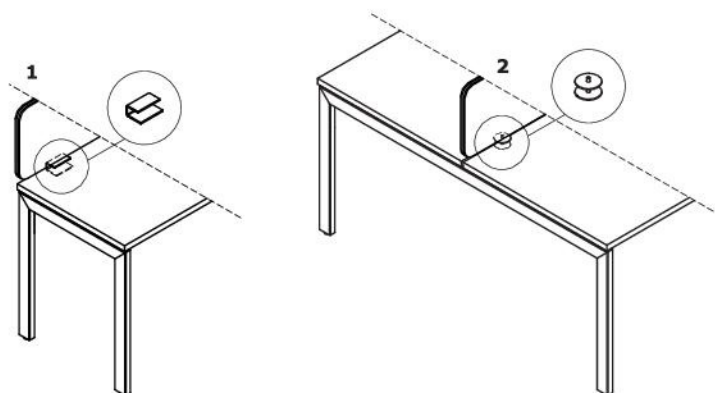

Poprzeczne - do biurek typu bench

- 1 Panel Twin** - tapicerowany, możliwość wpinania pinezek, pasek tworzywowy
- 2 Mocowanie paneli poprzecznych do biurek Ogi** - stopa 2 szt.

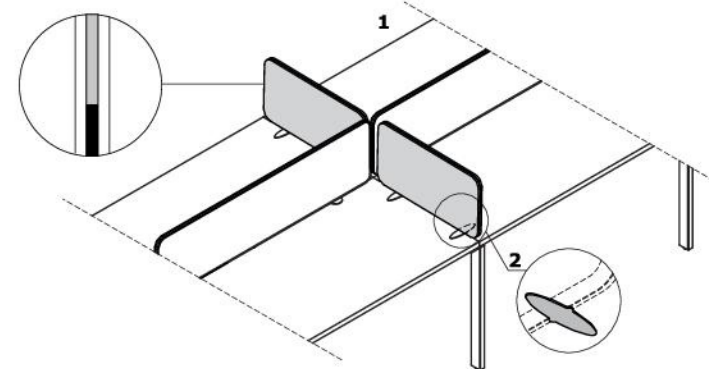

Boczne - do biurk pojedynczych i biurk typu bench

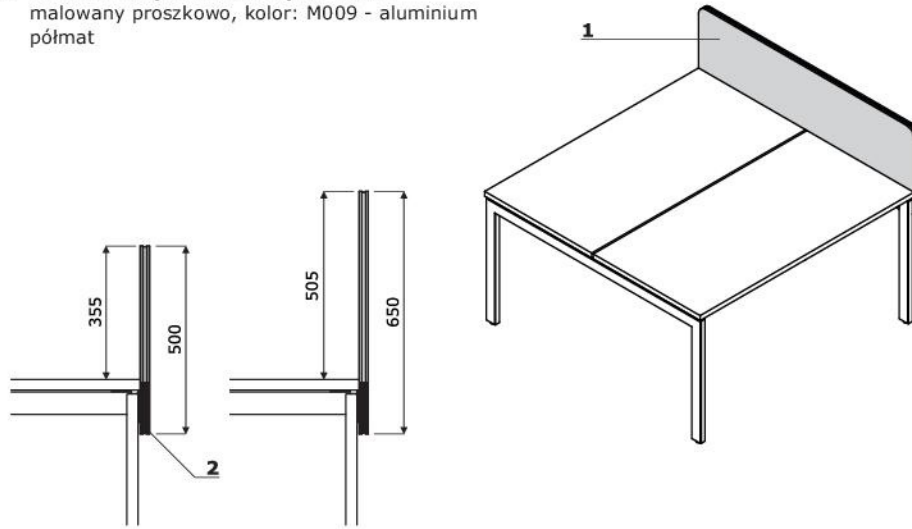

- 1 **Tkanina** - możliwość przypinania pinezek
- 2 **Mocowanie paneli bocznych** - metal malowany proszkowo, kolor: M009 - aluminium półmat

**Dodatki do listwy funkcyjnej**

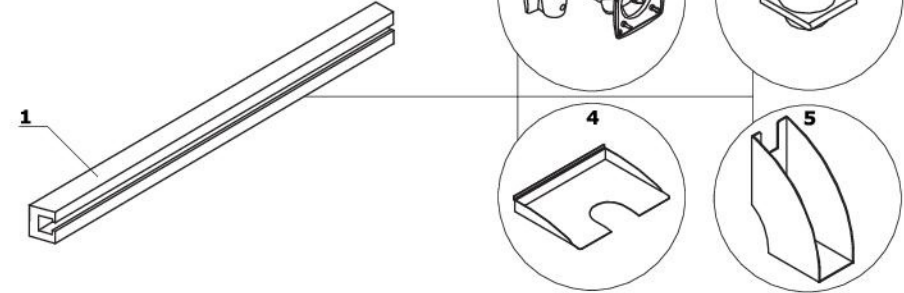
- 1 **Listwa funkcyjna** - max obciążenie: 3,5 kg na punkt, 7 kg na stronę
- 2 **Uchwyt na monitor** - metal malowany proszkowo, kolor: M009 - aluminium półmat
- 3 **Piórnik** - metal malowany proszkowo
- 4 **Półka** - format A4, metal malowany proszkowo
- 5 **Organizer** - metal malowany proszkowo



UWAGA: Możliwość mocowania akcesoriów wyłącznie z oferty .mdd

Nabiurkowe - do biurk pojedynczych i biurk typu bench						
Symbol	Wymiary	Wymiary			Waga Obj. Opak.	Uwagi
		Szer.	Gł.	Wys.		
 ZUT01		990	30	350	6.4 kg 0.016 m ³ 2 szt.	do biurk o szer. 1000 mm
ZUT12		1190	30	350	8.1 kg 0.019 m ³ 2 szt.	do biurk o szer. 1200 mm;
ZUT14		1390	30	350	9.6 kg 0.021 m ³ 2 szt.	do biurk o szer. 1400 mm;
ZUT16		1590	30	350	10.7 kg 0.024 m ³ 2 szt.	do biurk o szer. 1600 mm;
ZUT18		1790	30	350	10.9 kg 0.027 m ³ 2 szt.	do biurk o szer. 1800 mm;
ZUT20		1990	30	350	11.9 kg 0.029 m ³ 2 szt.	do biurk o szer. 2000 mm;
 ZUT05		990	30	500	8.6 kg 0.02 m ³ 2 szt.	do biurk o szer. 1000 mm
ZUT52		1190	30	500	10.6 kg 0.024 m ³ 2 szt.	do biurk o szer. 1200 mm;
ZUT54		1390	30	500	13.3 kg 0.028 m ³ 2 szt.	do biurk o szer. 1400mm;
ZUT56		1590	30	500	14 kg 0.031 m ³ 2 szt.	do biurk o szer. 1600mm;
ZUT58		1790	30	500	15.3 kg 0.035 m ³ 2 szt.	do biurk o szer. 1800mm;
ZUT59		1990	30	500	16.4 kg 0.039 m ³ 2 szt.	do biurk o szer. 2000mm;

I grupa cenowa	II grupa cenowa	chwyt do pojedynczego biurka	ostwa na akcesoria x1	ostwa na akcesoria x2	III grupa cenowa		



Nabiurkowe - do biurek pojedynczych i biurek typu bench - panel asymetryczny

Symbol	Wymiary	Waga Obj. Opak.	Uwagi
ZUT02	990 30 350 450	8 kg 0.018 m3 2 szt.	do biurek o szer. 1000 mm; panel asymetryczny
ZUT22	1190 30 350 450	8.6 kg 0.021 m3 2 szt.	do biurek o szer. 1200 mm; panel asymetryczny
ZUT24	1390 30 350 450	9.7 kg 0.025 m3 2 szt.	do biurek o szer. 1400 mm; panel asymetryczny
ZUT26	1590 30 350 450	11 kg 0.028 m3 2 szt.	do biurek o szer. 1600 mm; panel asymetryczny
ZUT28	1790 30 350 450	12.1 kg 0.035 m3 2 szt.	do biurek o szer. 1800 mm; panel asymetryczny
ZUT29	1990 30 350 450	14 kg 0.039 m3 2 szt.	do biurek o szer. 2000 mm; panel asymetryczny

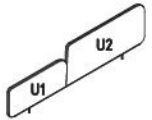
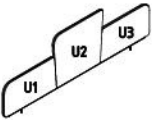
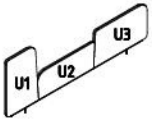
**Nabiurkowe - do biurek typu b**

	ZUT32	1190 30 360	7 kg 0.024 m3 1 szt.	do benchy o szer. 1200 mm;
	ZUT34	1390 30 360	8.8 kg 0.018 m3 1 szt.	do benchy o szer. 1400 mm;
	ZUT36	1590 30 560	11.9 kg 0.033 m3 1 szt.	do benchy o szer. 1600 mm;
	ZUT38	1790 30 560	13 kg 0.037 m3 1 szt.	do benchy o szer. 1800 mm;
	ZUT46	1590 30 560	10 kg 0.033 m3 1 szt.	do benchy o szer. 1600 mm;
	ZUT48	1790 30 560	11.1 kg 0.037 m3 1 szt.	do benchy o szer. 1800 mm;

grupa cenowa	II grupa cenowa	chwyt do pojedynczego biurka	stwa na akcesoria x1	stwa na akcesoria x2	grupa cenowa		

Nabiurkowe - do biurek typu bench z opcją blatu przesuwanego							
	Symbol	Wymiary			Waga Obj. Opak.	Uwagi	
		Szer.	Gł.	Wys.			
	ZUT01S	990	30	350	8.4 kg 0.018 m3 2 szt.	do biurek typu bench o szer. 1000 mm	
	ZUT12S	1190	30	350	10.1 kg 0.021 m3 2 szt.	do biurek typu bench o szer. 1200 mm	
	ZUT14S	1390	30	350	11.6 kg 0.024 m3 2 szt.	do biurek typu bench o szer. 1400 mm	
	ZUT16S	1590	30	350	12.7 kg 0.027 m3 2 szt.	do biurek typu bench o szer. 1600 mm	
	ZUT18S	1790	30	350	12.9 kg 0.029 m3 2 szt.	do biurek typu bench o szer. 1800 mm	
	ZUT20S	1990	30	350	13.9 kg 0.032 m3 2 szt.	do biurek typu bench o szer. 2000 mm	
	ZUT05S	990	30	500	10.6 kg 0.023 m3 2 szt.	do biurek typu bench o szer. 1000 mm	
	ZUT52S	1190	30	500	12.6 kg 0.027 m3 2 szt.	do biurek typu bench o szer. 1200 mm	
	ZUT54S	1390	30	500	15.3 kg 0.03 m3 2 szt.	do biurek typu bench o szer. 1400 mm	
	ZUT56S	1590	30	500	16 kg 0.034 m3 2 szt.	do biurek typu bench o szer. 1600 mm	
	ZUT58S	1790	30	500	17.3 kg 0.038 m3 2 szt.	do biurek typu bench o szer. 1800 mm	
	ZUT59S	1990	30	500	18.4 kg 0.041 m3 2 szt.	do biurek typu bench o szer. 2000 mm	

grupa cenowa	I grupa cenowa	II grupa cenowa	III grupa cenowa	IV grupa cenowa	V grupa cenowa			

Nabiurkowe - do biurek typu bench z opcją blatu przesuwanego - panel asymetryczny						
Symbol	Wymiary	Wymiary			Waga Obj. Opak.	Uwagi
		Szer.	Gł.	Wys.		
ZUT02S		990	30	350 450	10 kg 0.021 m3 2 szt.	do biurek typu bench o szer. 1000 mm; panel asymetryczny
ZUT22S		1190	30	350 450	10.6 kg 0.024 m3 2 szt.	do biurek typu bench o szer. 1200 mm; panel asymetryczny
ZUT24S		1390	30	350 450	11.7 kg 0.027 m3 2 szt.	do biurek typu bench o szer. 1400 mm; panel asymetryczny
ZUT26S		1590	30	350 450	13 kg 0.03 m3 2 szt.	do biurek typu bench o szer. 1600 mm; panel asymetryczny
ZUT28S		1790	30	350 450	14.1 kg 0.038 m3 2 szt.	do biurek typu bench o szer. 1800 mm; panel asymetryczny
ZUT29S		1990	30	350 450	16 kg 0.041 m3 2 szt.	do biurek typu bench o szer. 2000 mm; panel asymetryczny





I grupa cenowa	II grupa cenowa	akcesoria x1	akcesoria x2	III grupa cenowa			



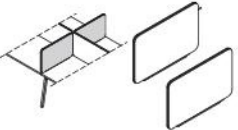

Przybiurkowe - do biurk pojedynczych z opcją blatu przesuwnego						
Symbol	Wymiary			Waga Obj. Opak.	Uwagi	
	Szer.	Gł.	Wys.			
ZPT610S	990	30	650	11.5 kg 0.031 m3 2 szt.	do biurk pojedynczych o szer. 1000mm	
ZPT612S	1190	30	650	13.5 kg 0.035 m3 2 szt.	do biurk pojedynczych o szer. 1200mm	
ZPT614S	1390	30	650	15.5 kg 0.04 m3 2 szt.	do biurk pojedynczych o szer. 1400mm	
ZPT616S	1590	30	650	17 kg 0.045 m3 2 szt.	do biurk pojedynczych o szer. 1600mm	
ZPT618S	1790	30	650	19 kg 0.049 m3 2 szt.	do biurk pojedynczych o szer. 1800mm	
ZPT620S	1990	30	650	20.5 kg 0.054 m3 2 szt.	do biurk pojedynczych o szer. 2000mm	
ZPT810S	990	30	800	13.5 kg 0.036 m3 2 szt.	do biurk pojedynczych o szer. 1000mm	
ZPT812S	1190	30	800	16 kg 0.042 m3 2 szt.	do biurk pojedynczych o szer. 1200mm	
ZPT814S	1390	30	800	18 kg 0.047 m3 2 szt.	do biurk pojedynczych o szer. 1400mm	
ZPT816S	1590	30	800	20.5 kg 0.053 m3 2 szt.	do biurk pojedynczych o szer. 1600mm	
ZPT818S	1790	30	800	22.5 kg 0.059 m3 2 szt.	do biurk pojedynczych o szer. 1800mm	
ZPT820S	1990	30	800	25 kg 0.064 m3 2 szt.	do biurk pojedynczych o szer. 2000mm	

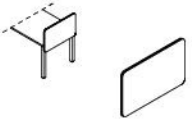

I grupa cenowa	II grupa cenowa	Costa na akcesoria x1	IV grupa cenowa				

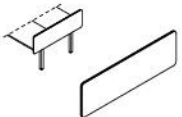
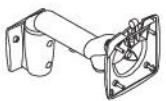
Poprzeczne - do biurek typu bench						
Symbol	Wymiary	Szer.	Gł.	Wys.	Waga Obj. Opak.	Uwagi
	ZYT78	1600	30	350	12 kg 0.014 m3 2 szt.	do benchy (kpl. 2 szt.);
	ZYT79	1600	30	500	12 kg 0.021 m3 2 szt.	
	ZOT58	577	30	350	3.4 kg 0.005 m3 1 szt.	do benchy Ogi (1 szt.);
	ZOT68	677	30	350	3.9 kg 0.006 m3 1 szt.	
	ZOT78	777	30	350	4.5 kg 0.007 m3 1 szt.	
	ZOT10	577	30	500	5.3 kg 0.008 m3 1 szt.	
	ZOT40	677	30	500	5.4 kg 0.009 m3 1 szt.	
	ZOT79	777	30	500	6.3 kg 0.01 m3 1 szt.	
Boczne - do biurek pojedynczych						
	ZUT80	600	30	500	5.5 kg 0.011 m3 2 szt.	wysokość panela liczona od poziomu blatu wynosi 350 mm
	ZUT90	700	30	500	6.4 kg 0.013 m3 2 szt.	
	ZUT30	800	30	500	7.3 kg 0.014 m3 2 szt.	
	ZUT60	600	30	650	7 kg 0.014 m3 2 szt.	wysokość panela liczona od poziomu blatu wynosi 500 mm
	ZUT70	700	30	650	8.1 kg 0.016 m3 2 szt.	
	ZUT50	800	30	650	9 kg 0.018 m3 2 szt.	

I grupa cenowa	II grupa cenowa	III grupa cenowa							

Boczne - do biurkek typu bench							
	Symbol	Wymiary			Waga Obj. Opak.	Uwagi	
		Szer.	Gł.	Wys.			
	ZUT11	1200	30	500	10.2 kg 0.02 m3 2 szt.	wysokość panela liczona od poziomu blatu wynosi 350 mm	
	ZUT41	1400	30	500	11.8 kg 0.023 m3 2 szt.		
	ZUT31	1600	30	500	13.3 kg 0.026 m3 2 szt.		
	ZUT61	1200	30	650	12.7 kg 0.025 m3 2 szt.	wysokość panela liczona od poziomu blatu wynosi 500 mm	
	ZUT71	1400	30	650	14.5 kg 0.029 m3 2 szt.		
	ZUT51	1600	30	650	17.2 kg 0.033 m3 2 szt.		
Akcesoria do listwy funkcyjnej							
	D1	300	130	130	1.9 kg 0.012 m3 1 szt.	uchwyt na monitor, max wielkość 22"	
	D5	164	83	146	0.2 kg 0.002 m3 1 szt.	Piórnik - tworzywo czarne, uchwyt - metal szary	
	D6	327	35	210	0.95 kg 0.002 m3 1 szt.	półka format A4	
	D7	93	250	180	0.6 kg 0.004 m3 1 szt.	organizer	

I grupa cenowa	II grupa cenowa	III grupa cenowa						
:	:	:	:	:	:	:	:	:
:	:	:	:	:	:	:	:	:
:	:	:	:	:	:	:	:	:
:	:	:	:	:	:	:	:	:
:	:	:	:	:	:	:	:	:
:	:	:	:	:	:	:	:	:
:	:	:	:	:	:	:	:	:
:	:	:	:	:	:	:	:	:

Zestawienie kolorystyczne - Sonic - panele ściienne i sufitowe

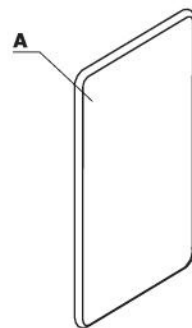

Materiał	Kolor	Panele													
		A - Panel													
Tkanina	Nemo	✓													
	Runner	II grupa ✓													
	Medley	II grupa ✓													
	**Atlantic	II grupa ✓													
	Vita	II grupa ✓													
	Mica	II grupa ✓													
	Go Check	II grupa ✓													
	****Charles	II grupa ✓													
	*Tkanina powierzona	II grupa ✓													
	Synergy	III grupa ✓													
	***Silvertex	III grupa ✓													
	Tessa	III grupa ✓													
	Oceanic	III grupa ✓													
	Quest	III grupa ✓													
	Grain	III grupa ✓													
	Atlas	IV grupa ✓													

* Zastosowanie tkaniny powierzonej wymaga przeprowadzenia prób tapicerskich, w celu sprawdzenia możliwości wykonawczych

** Istnieje możliwość zamówienia produktu w pełnej kolorystyce Atlantic wg wzornika Gabriel w terminie nie krótszym niż 7 tygodni

*** Istnieje możliwość zamówienia produktu w pełnej kolorystyce Silvertex wg wzornika Spradling w terminie nie krótszym niż 15 dni roboczych

**** Istnieje możliwość zamówienia produktu w pełnej kolorystyce Charles wg wzornika Dekoma w standardowym terminie realizacji.

Sonic - panele akustyczne ściennie

- 1 Panel** - tapicerowany jednostronnie, konstrukcja wykonana w technologii paneli Sonic, posiadających certyfikat akustyczności klasy A, możliwość wpinania szpilek
- 2 Rama** - konstrukcja z litego drewna klejonego
- 3 Wypełnienie** - włóknina akustyczna o wysokim stopniu pochłaniania i rozpraszania dźwięków
- 4 Zawieszka** - do mocowania na ścianie (w komplecie kołki do mocowania do ścian pełnych i z płyt gipsowo-kartonowych)

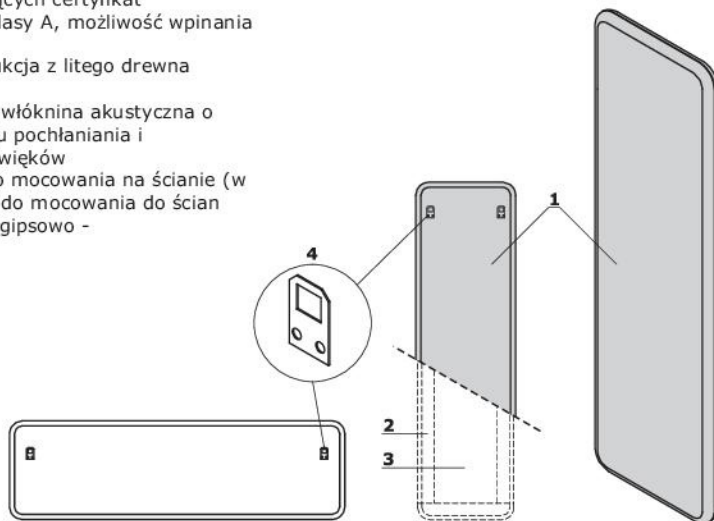

Sonic - panele akustyczne sufitowe

- 1 Panele sufitowe** - tapicerowany jednostronnie, konstrukcja wykonana w technologii paneli Sonic, posiadających certyfikat akustyczności klasy A
- 2 Linka stalowa** - stal nierdzewna, możliwość regulacji długości paneli wiszących pionowo w zakresie 100 - 900 mm oraz paneli wiszących poziomo w zakresie 200 - 1400 mm

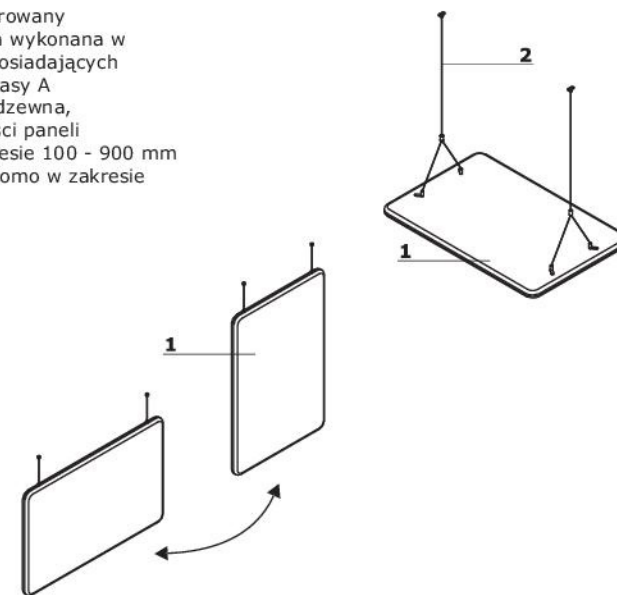

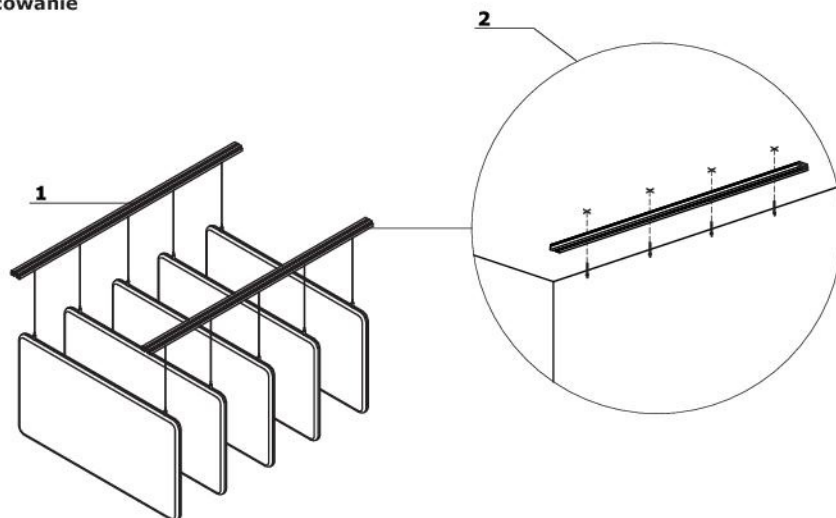

Sonic - panele sufitowe - szyna do wieszania paneli

- 1 Szyna** - aluminium, 2szt.
- 2 Mocowanie**





UWAGA - kołki rozporowe do sufitów betonowych z atestem ITB – odporność ogniowa A1.

Sonic - panele akustyczne ściienne							
	Symbol		Wymiary			Waga Obj. Opak.	Uwagi
			Szer.	Gł.	Wys.		
	ZAK312		350	40	1190	4 kg 0.023 m ³ 1 szt.	montaż poziomo lub pionowo; tapicerowany jednostronnie
	ZAK318		350	40	1790	6.2 kg 0.034 m ³ 1 szt.	
	ZAK612		650	40	1190	5.1 kg 0.041 m ³ 1 szt.	
	ZAK618		650	40	1790	6.9 kg 0.061 m ³ 1 szt.	
Sonic - panele sufitowe - mocowanie dłuższą krawędzią do sufitu							
	ZUS12G		1190	40	350	10 kg 0.027 m ³ 1 szt.	Wyrób bez możliwości Montażu Fabrycznego. Nie wlicza się do kosztów Montażu.
	ZUS14G		1390	40	350	10 kg 0.031 m ³ 1 szt.	
	ZUS16G		1590	40	350	10 kg 0.036 m ³ 1 szt.	
	ZUS18G		1790	40	350	10 kg 0.04 m ³ 1 szt.	
	ZUS20G		1990	40	350	10 kg 0.045 m ³ 1 szt.	
Sonic - panele sufitowe - mocowanie dłuższą lub krótszą krawędzią do sufitu							
	ZUS05G		990	40	500	10 kg 0.032 m ³ 1 szt.	Wyrób bez możliwości Montażu Fabrycznego. Nie wlicza się do kosztów Montażu.
	ZUS2G		1190	40	500	10 kg 0.038 m ³ 1 szt.	
	ZUS4G		1390	40	500	10 kg 0.044 m ³ 1 szt.	
	ZUS6G		1590	40	500	10 kg 0.05 m ³ 1 szt.	
	ZUS8G		1790	40	500	10 kg 0.056 m ³ 1 szt.	
	ZUS9G		1990	40	500	10 kg 0.063 m ³ 1 szt.	

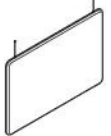
grupa cenowa	II grupa cenowa	III grupa cenowa							



Sonic - panele sufitowe - mocowanie dłuższą lub krótszą krawędzią do sufitu							
	Symbol	Wymiary			Waga Obj. Opak.	Uwagi	
		Szer.	Gł.	Wys.			
	ZPS610G	990	40	650	10 kg 0.041 m ³ 1 szt.	Wyrób bez możliwości Montaży Fabrycznego. Nie wlicza się do kosztów Montaży.	
	ZPS612G	1190	40	650	10 kg 0.049 m ³ 1 szt.		
	ZPS614G	1390	40	650	10 kg 0.057 m ³ 1 szt.		
	ZPS616G	1590	40	650	10 kg 0.065 m ³ 1 szt.		
	ZPS618G	1790	40	650	10 kg 0.073 m ³ 1 szt.		
	ZPS620G	1990	40	650	10 kg 0.081 m ³ 1 szt.		
		ZPS810G	990	40	800		
ZPS812G		1190	40	800	10 kg 0.06 m ³ 1 szt.		
ZPS814G		1390	40	800	10 kg 0.069 m ³ 1 szt.		
ZPS816G		1590	40	800	10 kg 0.079 m ³ 1 szt.		
ZPS818G		1790	40	800	10 kg 0.089 m ³ 1 szt.		
ZPS820G		1990	40	800	10 kg 0.099 m ³ 1 szt.		

grupa cenowa	II grupa cenowa	III grupa cenowa					

Sonic - panele sufitowe - mocowane poziomo						
Symbol	Wymiary	Wymiary			Waga Obj. Opak.	Uwagi
		Szer.	Gł.	Wys.		
	ZUS05GP	990	40	500	10 kg 0.032 m3 1 szt.	Wyrób bez możliwości Montażu Fabrycznego. Nie wlicza się do kosztów Montażu.
	ZUS52GP	1190	40	500	10 kg 0.038 m3 1 szt.	
	ZUS54GP	1390	40	500	10 kg 0.044 m3 1 szt.	
	ZUS56GP	1590	40	500	10 kg 0.05 m3 1 szt.	
	ZUS58GP	1790	40	500	10 kg 0.056 m3 1 szt.	
	ZUS59GP	1990	40	500	10 kg 0.063 m3 1 szt.	
	ZPS610GP	990	40	650	10 kg 0.041 m3 1 szt.	Wyrób bez możliwości Montażu Fabrycznego. Nie wlicza się do kosztów Montażu.
	ZPS612GP	1190	40	650	10 kg 0.049 m3 1 szt.	
	ZPS614GP	1390	40	650	10 kg 0.057 m3 1 szt.	
	ZPS616GP	1590	40	650	10 kg 0.065 m3 1 szt.	
	ZPS618GP	1790	40	650	10 kg 0.073 m3 1 szt.	
	ZPS620GP	1990	40	650	10 kg 0.081 m3 1 szt.	

I grupa cenowa	II grupa cenowa	III grupa cenowa							

Sonic - panele sufitowe - mocowane poziomo

Symbol	Wymiary			Waga Obj. Opak.	Uwagi	
	Szer.	Gł.	Wys.			
	ZPS810GP	990	40	800	10 kg 0.05 m3 1 szt.	Wyrób bez możliwości Montażu Fabrycznego. Nie wlicza się do kosztów Montażu.
ZPS812GP	1190	40	800	10 kg 0.06 m3 1 szt.		
ZPS814GP	1390	40	800	10 kg 0.069 m3 1 szt.		
ZPS816GP	1590	40	800	10 kg 0.079 m3 1 szt.		
ZPS818GP	1790	40	800	10 kg 0.089 m3 1 szt.		
ZPS820GP	1990	40	800	10 kg 0.099 m3 1 szt.		
Akcesoria						
	ZSZ200	2000	30	30	0 kg 0 m3 0 szt.	szyna do wieszania paneli sufitowych (2 szt.)

I grupa cenowa	II grupa cenowa	III grupa cenowa						

Zestawienie kolorystyczne - Bazalto - panele ściennie

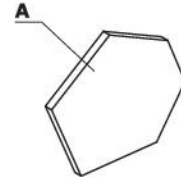

Materiał	Kolor	Panele															
		A - Panel															
Tkanina	Nemo	✓															
	Runner	II grupa ✓															
	Medley	II grupa ✓															
	**Atlantic	II grupa ✓															
	Vita	II grupa ✓															
	Mica	II grupa ✓															
	Go Check	II grupa ✓															
	****Charles	II grupa ✓															
	Synergy	III grupa ✓															
	***Silvertex	III grupa ✓															
	Tessa	III grupa ✓															
	Oceanic	III grupa ✓															
	Quest	III grupa ✓															
	Grain	III grupa ✓															
	*Tkanina powierzona	II grupa ✓															
	Atlas	IV grupa ✓															

* Zastosowanie tkaniny powierzonej wymaga przeprowadzenia prób tapicerskich, w celu sprawdzenia możliwości wykonawczych

** Istnieje możliwość zamówienia produktu w pełnej kolorystyce Atlantic wg wzornika Gabriel w terminie nie krótszym niż 7 tygodni

*** Istnieje możliwość zamówienia produktu w pełnej kolorystyce Silvertex wg wzornika Spradling w terminie nie krótszym niż 15 dni roboczych

**** Istnieje możliwość zamówienia produktu w pełnej kolorystyce Charles wg wzornika Dekoma w standardowym terminie realizacji.

Bazalto - panele ścienne

- Panel** - tapicerowany jednostronnie, konstrukcja wykonana w technologii paneli Sonic, posiadających certyfikat akustyczności klasy A, możliwość wpinania szpilek
- Rama** - płyta wiórowa
- Wypełnienie** - włóknina akustyczna o wysokim stopniu pochłaniania i rozpraszania dźwięków
- Mocowanie** - klej (1 opakowanie na 6 szt. paneli) - zamawiany jako oddzielny element (symbol BKL1)

Bazalto - panele ścienne							
	Symbol		Wymiary			Waga Obj. Opak.	Uwagi
			Szer.	Gł.	Wys.		
	BWP1		650	21	550	1.7 kg 0.01 m3 1 szt.	w przypadku zamawiania paneli konieczność domówienia kleju montażowego BKL1 (zamawiany jako oddzielna pozycja)
	BWP2		650	39	550	2.3 kg 0.019 m3 1 szt.	
Klej do paneli							
	BKL1		220	50	50	0.4 kg 0.001 m3 1 szt.	klej do paneli; Bazalto (1 opakowanie na 6 szt. paneli), Mix (1 opakowanie na 6 szt. paneli małych lub 3 duże)

grupa cenowa	I grupa cenowa	II grupa cenowa	III grupa cenowa						

Zestawienie kolorystyczne - Mix - panele ściienne i sufitowe

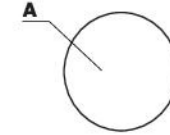
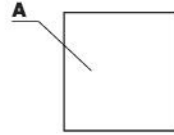

Materiał	Kolor	Panele														
		A - Panel														
Tkanina	Nemo	✓														
	Runner	II grupa ✓														
	Medley	II grupa ✓														
	**Atlantic	II grupa ✓														
	Vita	II grupa ✓														
	Mica	II grupa ✓														
	Go Check	II grupa ✓														
	****Charles	II grupa ✓														
	*Tkanina powierzona	II grupa ✓														
	Synergy	III grupa ✓														
	***Silvertex	III grupa ✓														
	Tessa	III grupa ✓														
	Oceanic	III grupa ✓														
	Quest	III grupa ✓														
	Grain	III grupa ✓														
	Atlas	IV grupa ✓														

* Zastosowanie tkaniny powierzonej wymaga przeprowadzenia prób tapicerskich, w celu sprawdzenia możliwości wykonawczych

** Istnieje możliwość zamówienia produktu w pełnej kolorystyce Atlantic wg wzornika Gabriel w terminie nie krótszym niż 7 tygodni

*** Istnieje możliwość zamówienia produktu w pełnej kolorystyce Silvertex wg wzornika Spradling w terminie nie krótszym niż 15 dni roboczych

**** Istnieje możliwość zamówienia produktu w pełnej kolorystyce Charles wg wzornika Dekoma w standardowym terminie realizacji.

Mix - panele ściienne i sufitowe

- 1 Panele ściienne** - tapicerowany jednostronnie, konstrukcja wykonana w technologii paneli Sonic, posiadających certyfikat akustyczności klasy A
- 2 Panele sufitowe** - tapicerowany jednostronnie, konstrukcja wykonana w technologii paneli Sonic, posiadających certyfikat akustyczności klasy A
- 3 Rama** - płyta wiórowa
- 4 Wypełnienie** - włóknina akustyczna o wysokim stopniu pochłaniania i rozpraszania dźwięków
- 5 Mocowanie** - klej (1 opakowanie na 6 szt. paneli) - zamawiany jako oddzielny element (symbol BKL1)
- 6 Linka stalowa** - stal nierdzewna, możliwość regulacji długości 200 - 1400 mm

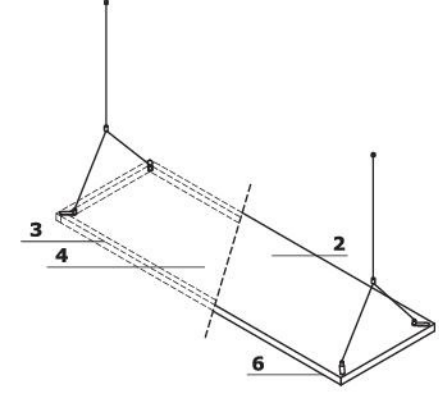
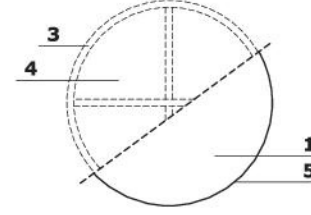
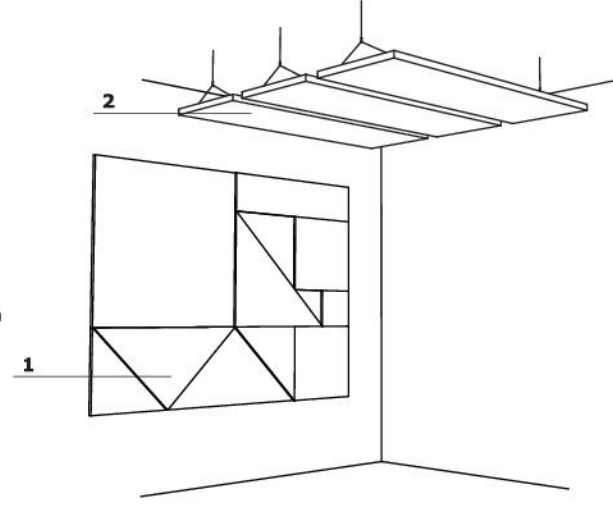



Mix - panele ściennie							
Symbol	Wymiary	Wymiary			Waga Obj. Opak.	Uwagi	
		Szer.	Gł.	Wys.			
MX01P		600	28	300	1.2 kg 0.008 m3 1 szt.	w przypadku zamawiania paneli konieczność domówienia kleju montażowego BKL1 (zamawiany jako oddzielna pozycja)	
MX01PG		600	45	300	1.7 kg 0.012 m3 1 szt.		
MX02P		900	28	300	1.7 kg 0.012 m3 1 szt.		
MX02PG		900	45	300	2.4 kg 0.017 m3 1 szt.		
MX03P		1200	28	300	2.1 kg 0.015 m3 1 szt.		
MX03PG		1200	45	300	3.2 kg 0.023 m3 1 szt.		
MX08P		1800	28	600	5.4 kg 0.045 m3 1 szt.		
MX08PG		1800	45	600	5.5 kg 0.067 m3 1 szt.		
MX09P		2400	28	600	7.1 kg 0.059 m3 1 szt.		
MX09PG		2400	45	600	7 kg 0.089 m3 1 szt.		





I grupa cenowa	II grupa cenowa	III grupa cenowa							

Mix - panele ścienne							
	Symbol		Wymiary			Waga Obj. Opak.	Uwagi
			Szer.	Gł.	Wys.		
	MX04P		300	28	300	0.4 kg 0.004 m3 1 szt.	w przypadku zamawiania paneli konieczność domówienia kleju montażowego BKL1 (zamawiany jako oddzielna pozycja)
	MX04PG		300	45	300	1 kg 0.006 m3 1 szt.	
	MX05P		600	28	600	2.2 kg 0.015 m3 1 szt.	
	MX05PG		600	45	600	3 kg 0.023 m3 1 szt.	
	MX06P		900	28	900	4.3 kg 0.033 m3 1 szt.	
	MX06PG		900	45	900	6 kg 0.05 m3 1 szt.	
	MX07P		1200	28	1200	7.7 kg 0.059 m3 1 szt.	
	MX07PG		1200	45	1200	9.6 kg 0.089 m3 1 szt.	
	MX10P		600	28	600	1.7 kg 0.015 m3 1 szt.	
MX10PG		600	45	600	2.3 kg 0.023 m3 1 szt.		
MX11P		900	28	900	3.7 kg 0.033 m3 1 szt.		
MX11PG		900	45	900	5.1 kg 0.05 m3 1 szt.		
MX12P		1200	28	1200	5.9 kg 0.059 m3 1 szt.		
MX12PG		1200	45	1200	13.5 kg 0.089 m3 1 szt.		

grupa cenowa I	grupa cenowa II	grupa cenowa III					

Mix - panele ścienne						
Symbol	Wymiary	Wymiary			Waga Obj. Opak.	Uwagi
		Szer.	Gł.	Wys.		
	MX13P	600	28	600	1.3 kg 0.015 m3 1 szt.	w przypadku zamawiania paneli konieczność domówienia kleju montażowego BKL1 (zamawiany jako oddzielna pozycja)
MX13PG	600	45	600	1.9 kg 0.023 m3 1 szt.		
MX14P	900	28	900	6.2 kg 0.033 m3 1 szt.		
MX14PG	900	45	900	2.8 kg 0.05 m3 1 szt.		
MX15P	1200	28	1200	8.7 kg 0.059 m3 1 szt.		
MX15PG	1200	45	1200	2.2 kg 0.089 m3 1 szt.		
	MX16P	900	28	450	1.7 kg 0.017 m3 1 szt.	
MX16PG	900	45	450	2.2 kg 0.026 m3 1 szt.		
MX17P	1200	28	600	2.5 kg 0.03 m3 1 szt.		
MX17PG	1200	45	600	3.5 kg 0.045 m3 1 szt.		

I grupa cenowa	II grupa cenowa	III grupa cenowa						







Mix - panele sufitowe							
	Symbol		Wymiary			Waga Obj. Opak.	Uwagi
			Szer.	Gł.	Wys.		
	MX06S		900	45	900	4.5 kg 0.05 m ³ 1 szt.	Wyrób bez możliwości Montażu Fabrycznego. Nie wlicza się do kosztów Montażu.
	MX07S		1200	45	1200	6.4 kg 0.089 m ³ 1 szt.	Wyrób bez możliwości Montażu Fabrycznego. Nie wlicza się do kosztów Montażu.
	MX08S		1800	45	600	7.4 kg 0.067 m ³ 1 szt.	Wyrób bez możliwości Montażu Fabrycznego. Nie wlicza się do kosztów Montażu.
	MX09S		2400	45	600	8 kg 0.089 m ³ 1 szt.	Wyrób bez możliwości Montażu Fabrycznego. Nie wlicza się do kosztów Montażu.
	MX11S		900	45	900	5.5 kg 0.05 m ³ 1 szt.	Wyrób bez możliwości Montażu Fabrycznego. Nie wlicza się do kosztów Montażu.
	MX12S		1200	45	1200	8.4 kg 0.089 m ³ 1 szt.	Wyrób bez możliwości Montażu Fabrycznego. Nie wlicza się do kosztów Montażu.
	MX14S		900	45	900	3.8 kg 0.05 m ³ 1 szt.	Wyrób bez możliwości Montażu Fabrycznego. Nie wlicza się do kosztów Montażu.
	MX15S		1200	45	1200	5.3 kg 0.089 m ³ 1 szt.	Wyrób bez możliwości Montażu Fabrycznego. Nie wlicza się do kosztów Montażu.
Klej do paneli							
	BKL1		220	50	50	0.4 kg 0.001 m ³ 1 szt.	klej do paneli; Bazalto (1 opakowanie na 6 szt. paneli), Mix (1 opakowanie na 6 szt. paneli małych lub 3 duże)

I grupa cenowa	II grupa cenowa	III grupa cenowa								









Metal

 M009 - aluminium półmat RAL 9006	 M015 - biały półmat RAL 9010	 M115 - czarny półmat RAL 9005	 M154 - antracyt półmat RAL 7043
--	--	---	--

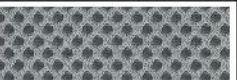
Tkanina Nemo - I grupa cenowa

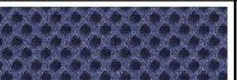
 NE-1 - beżowy	 NE-2 - żółty	 NE-3 - pomarańczowy	 NE-5 - czerwony	 NE-9 - zielony	 NE-10 - szary	 NE-14 - grafitowy	 NE-15 - granatowy
 NE-16 - czarny	 NE-17 - niebieski						











Tkanina Runner - II grupa cenowa

 R-63034 - pomarańczowy	 R-64089 - czerwony	 R-66063 - niebieski	 R-60011 - szary	 R-68056 - zielony	 R-66064 - granatowy	 R-60999 - czarny	 R-60025 - grafitowy
 R-61128 - beżowy	 R-68110 - Ciemny zielony						



Tkanina Medley - II grupa cenowa

 M-66008 - szary	 M-60003 - jasny szary	 M-61189 - beżowy	 M-68005 - ciemny oliwkowy	 M-62002 - żółty	 M-62054 - musztardowy	 M-63017 - rdzawy	 M-64019 - czerwony
 M-63064 - różowy	 M-65011 - szarofioletowy	 M-66010 - niebieski	 M-67006 - jasny niebieski	 M-60999 - czarny			

Tkanina Atlantic - II grupa cenowa (Pozostałe kolory Atlantic wg wzornika Gabriel dostępne w terminie nie krótszym niż 7 dni roboczych)

 A-67043 - ciemny turkusowy	 A-67030 - morski	 A-60141 - jasny szary	 A-60011 - szary	 A-66064 - granatowy	 A-65037 - fioletowy	 A-62048 - oliwkowy	 A-64089 - czerwony
 A-61078 - beżowy	 A-60025 - grafitowy						

Tkanina Vita - II grupa cenowa

 V-01 - jasny szary	 V-02 - beżowy	 V-03 - żółty	 V-04 - szary	 V-07 - ciemny szary	 V-09 - oliwkowy	 V-10 - szarobrązowy	 V-11 - rdzawy
 V-12 - czarny	 V-39 - czekoladowy	 V-18 - morski	 V-19 - niebieski	 V-29 - ciemny zielony	 V-44 - beżowy	 V-46 - brązowy	





Tkanina Go check - II grupa cenowa

 G-66136 - niebieski	 G-66135 - jasny niebieski	 G-60080 - ciemny szary	 G-66138 - granatowy	 G-60084 - ciemny grafitowy	 G-68149 - ciemny zielony	 G-68152 - zielony	 G-60079 - szary
 G-64183 - marsala	 G-63079 - pomarańczowy	 G-64171 - czerwony	 G-64172 - bordowy	 G-61144 - brązowy	 G-61145 - ciemny brązowy		

Tkanina Charles - II grupa cenowa (Istnieje możliwość zamówienia produktu w pełnej kolorystyce Charles wg wzornika Dekoma w standardowym terminie realizacji.)

 C-01 - czarny	 C-05 - szary	 C-06 - beżowy	 C-14 - brązowy	 C-18 - rdzawy	 C-21 - czerwony	 C-30 - różowy	 C-31 - marsala
 C-32 - niebieski ciemny	 C-35 - niebieski	 C-41 - żółty	 C-44 - oliwkowy	 C-45 - zielony			

Tkanina Mica - II grupa cenowa

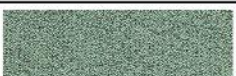
 MC-01 - różowy	 MC-02 - czerwony	 MC-03 - ciemny czerwony	 MC-04 - granatowy	 MC-05 - niebieski	 MC-06 - morski	 MC-07 - zielony butelkowy	 MC-08 - zielony
 MC-09 - oliwkowy	 MC-10 - jasny oliwkowy	 MC-11 - musztardowy	 MC-12 - żółty	 MC-13 - beżowy	 MC-14 - jasny szary	 MC-15 - szary	 MC-16 - grafitowy
 MC-17 - niebieski jasny	 MC-18 - miętowy	 MC-19 - bordowy					











Tkanina Synergy - III grupa cenowa

 LDS08 - szary melanz	 LDS20 - jasny szary	 LDS27 - czarny	 LDS29 - ciemny szary	 LDS50 - ciemny zielony	 LDS57 - turkusowy	 LDS60 - zielony butelkowy	 LDS61 - śliwkowy
 LDS69 - granatowy	 LDS84 - pomarańczowy	 LDS86 - czerwony	 LDS88 - oberżyna	 LDS19 - beżowy	 LDS44 - żółty	 LDS79 - brązowy	

Tkanina Tessa - III grupa cenowa

 T-08 - kremowy	 T-09 - beżowy	 T-05 - szary	 T-03 - ciemny szary	 T-02 - grafitowy
---	--	---	---	---

Tkanina Oceanic - III grupa cenowa

 O-16 - różowy	 O-05 - koralowy	 O-12 - czerwony	 O-07 - żółty	 O-04 - jasny zielony	 O-15 - jasny niebieski	 O-11 - niebieski	 O-13 - jasny szary
 O-08 - ciemny szary	 O-01 - czarny						

Tkanina Quest - III grupa cenowa

 Q-26 - różowy	 Q-25 - pomarańczowy	 Q-24 - czerwony	 Q-21 - pastelowy żółty	 Q-19 - beżowy	 Q-18 - oliwkowy	 Q-13 - jasny zielony	 Q-07 - jasny niebieski
 Q-08 - granatowy	 Q-04 - grafitowy						

Tkanina Silvertex - III grupa cenowa - Istnieje możliwość zamówienia produktu w pełnej kolorystyce Silvertex wg wzornika Spradling w terminie nie krótszym niż 15 dni roboczych.

Tkanina Grain - III grupa cenowa

 GR-64249 - różowy	 GR-62122 - żółty	 GR-62016 - jasny pomarańczowy	 GR-63117 - pomarańczowy	 GR-68243 - oliwkowy	 GR-66236 - błękitny	 GR-66232 - granatowy	 GR-60301 - szary
 GR-61252 - beżowy	 GR-61250 - biały						

Tkanina Atlas - IV grupa cenowa

 AS-531 - pomarańczowy	 AS-501 - różowy	 AS-651 - czerwony	 AS-681 - bordowy	 AS-391 - brązowy	 AS-781 - granatowy	 AS-161 - ciemny szary	 AS-111 - jasny szary
 AS-971 - jasny zielony	 AS-981 - ciemny zielony						